

BaerCoil® Wire Thread Inserts
type: “screw grip”





BaerCoil® Thread Reinforcement & Thread Repair

BaerCoil® Wire Thread Inserts - type: "free running"

BaerCoil® thread inserts are made from austenitic chromium-nickel steel (stainless steel AISI 304 with a material tensile strength of at least 1400 N/mm²). In production the wire is swaged in cold-form to a rhombic cross-section, which ensures performance and maximum space utilization. With BaerCoil® thread inserts you achieve a better thread connection in regard to wear resistance, thread abrasion, surface finish, corrosion- and heat resistance than with any other single screw connection.



BaerCoil® Wire Thread Inserts - type: "screw grip"

In addition to "free-running" insert characteristics, BaerCoil® "screw grip" thread inserts have one or more polygon-formed windings, which have a clamping effect on the flanks of the inserted screw. We only recommend using screws with a higher screw property class (from 8.8 on) because of this screw locking or screw clamping effect. An elastic and flexible frictional connection is formed. The clamping torque is comparable to the indications in DIN 267 Part 15 and ISO 2320. BaerCoil® "screw grip" thread inserts are predominantly used in areas where screw connections must remain tight while exposed to impacts, constant vibrations and movements.

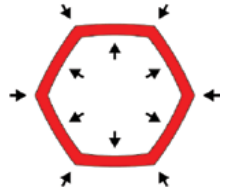

i see locking torque values on page 7

Thread Reinforcement and higher tensile strength

BaerCoil® thread inserts reinforce and increase the pull-out strength especially in materials with low shear strength, as e.g.: aluminum or magnesium.

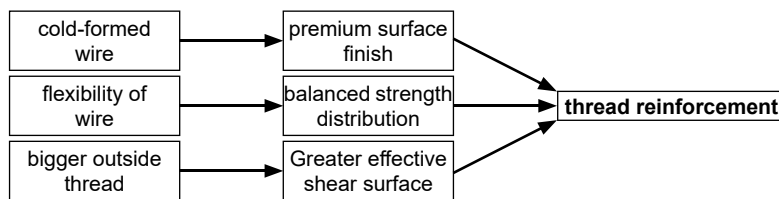

example from test results	
material	Magnesium
thread - length	M 10 x 1,5 - 10 mm
pull-out strength without BaerCoil	3540 kg/mm ²
pull-out strength with BaerCoil	4570 kg/mm ²
relative increase	about 29 %

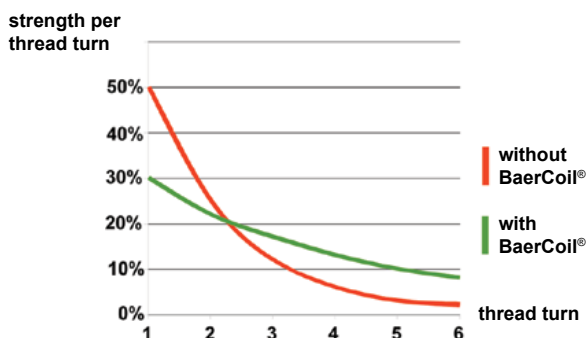
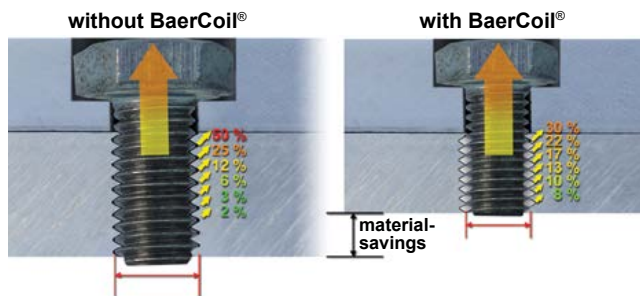

Premium surface finish

BaerCoil® thread inserts have a premium surface finish (about 2,5 µm) and are made predominantly from stainless steel (AISI 304) or other materials with a hardness (min. 425 HV 0,2) that far exceeds normal screw connections. For repetitive screw connections these properties ensure, among other things, a higher and consistent tension force at the same torque strength. This leads to a better utilization of yield strength. The torsion tension is up to 90% less than for threads without BaerCoil® thread inserts.

Balanced strength distribution

Threads with BaerCoil® inserts more evenly distribute static and dynamic workloads to the individual thread turns. The flexibility of the inserts compensates for the rise- and angle errors, achieving an ideal force transmission from the bolt to the thread of the nut.

Greater effective shear surface

The BaerCoil® wire thread insert has a greater effective shear surface than a normal screw connection with cut thread turns. The shear surface refers to the contact surface of the wire thread insert or screw with the cut outer thread. The greater this surface, the less the force that affects a square mm.

Protection against wear of a thread

BaerCoil® thread inserts protect the thread against wear and damage in all metals and their alloys, as e.g. aluminum, magnesium, titanium, copper, steel, plastic and other materials. The thread insert is very hard and has a premium surface finish. Since the surface has minimal roughness, less friction force affects the thread when inserting the screw. The decrease in thread friction force also minimizes wear.

Corrosion-resistance

BaerCoil® thread inserts also have excellent corrosion-resistance properties. This ensures applicability in almost all materials and under most conditions.

Flexibility

BaerCoil® thread inserts were constructed to be axially and radially elastic. This ensures that each winding can adjust independently and thereby compensate for rise- and angle errors that exist between the inner thread and the screw. The force is distributed evenly to all thread turns.

Reductions of weight and space

The reduction in weight is an uncontested and important design element for many products. Due to the high thread resilience of BaerCoil® thread inserts, the usage of smaller thread diameters and shorter thread lengths is possible. The extremely high resilience of the clad thread allows for, depending on material and size, material savings of up to ca. 10 - 30 %. BaerCoil® thread inserts save material, building space and weight while fulfilling the same or higher requirements.

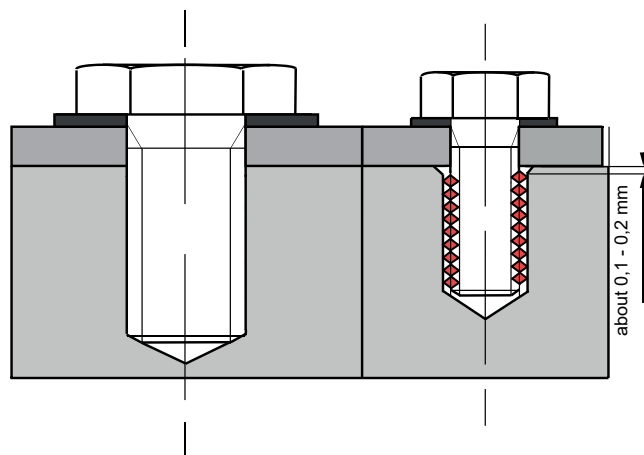

Minimize total costs

Since less material is needed, BaerCoil® inserts reduce production costs while still providing the required solidity of the thread connection. Moreover, follow-up costs are very low: Lighter vehicles and aircrafts require less gasoline or kerosene. Expensive spare parts and elaborate installations can be avoided with thread cladding, and damaged threads can be repaired easily.

Thread Repair

Besides thread reinforcement, the BaerCoil® thread insert also facilitates the repair of damaged threads. Rejected parts can be salvaged while maintaining the original thread size. Additionally, the thread is strengthened in its pull-out- and corrosion resistance. In maintenance the use of these thread inserts saves procurement- and processing costs for spare parts.



Applications

BaerCoil® thread inserts are especially well suited for the following materials:

- Aluminum and aluminum alloys
- Brass, bronze, cast-iron
- Magnesium alloys
- Steels etc.

Application examples:

- Motor vehicle industry: Motor, transmission, radiator, vehicle body parts, oil drain etc.
- Aerospace: Engines, assembly parts reinforcement etc.
- Electronic- and laboratory technology: Medical devices, capacitors, casings etc.
- Household appliances: Hole punch, iron, pocket calculator, cameras, cell phones
- Facility- and device construction: Pumps, construction machines, various components etc.
- Military devices: Airplanes, weapons, tanks, scopes etc.







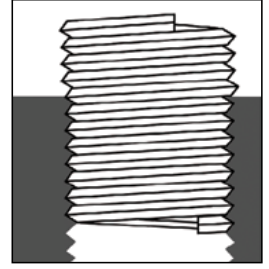

Design

The outer diameter of non-installed BaerCoil® thread inserts is larger by a fixed measure than the receiving thread. This is necessary in order to apply radial pressure during installation to the inner thread of the receiving thread. This radial pressure safely and firmly seats the thread insert in the receiving thread. Additional securing elements are, therefore, not required. The thread insert adjusts to the thread turns and slightly expands in length. This is why the length of the thread insert can only be measured when installed since it lengthens while being pressed together as it adjusts to the cut thread.

Each thread insert size is available in 5 lengths. Lengths range from 1 x, 1.5 x, 2 x, 2.5 x and 3 times the size of the thread diameter. Other lengths are available upon request.



Materials

	Material	Tensile Strength	Temperature resistance	Examples of use	
	Stainless Steel V2A AISI 304 X5CrNi18-10 Material-No.: 1.4301	>1400 N/mm ²	315°C long-term 425°C short-term	standard applications for all property classes and materials for Thread Repair and Thread Reinforcement	
	Stainless Steel V4A AISI 316 Ti X6CrNiMoTi17-12-2 Material-No.: 1.4571	>1400 N/mm ²	315°C long-term 425°C short-term	- increased corrosion protection - low thread friction - for high alloyed CrNi steel screws	general lightweight construction sea water and chlorine-containing water
	Inconel X750 NiCr15Fe7TiAl Material-No.: 2.4669	>1150 N/mm ²	550°C long-term 750°C short-term	- high thermal load - high corrosion protection	- aerospace technology - turbocharger - aeroplane engines - turbines - thermal power plants
	Bronze CuSn6 CW452K Material-No.: 2.1020	> 900 N/mm ²	250°C long-term 300°C short-term	- translation threads - CrNi screws - Cu workpieces - non-magnetic	applications in sea water best electric conductivity

Surface treatments

surface treatments	color	applications
cadmium plating	iridescent yellow	provides high corrosion resistance and lubrication to prevent galling - suitable up to 250°C
zinc plating	white	provides corrosion resistance as an alternative to cadmium
silver plating	silver white	to reduce galling of threads at high temperatures
cadmium plate & olive drab	olive drab	as specified on US military specs such as NASM21209.
Dry Film Lubricated	grey	additional lubrication in high friction applications - recommended for use with screw grip inserts

Compatibility

BaerCoil® wire thread inserts and tools are compatible with wire thread inserts and tools from other manufacturers, in most cases. BaerCoil® inserts are mainly manufactured according to DIN 8140 so they have the same dimensions. Other standards like DIN65536, EN2944, LN9039, LN9490, LN9499, NASM21209, AS4736 to 4748, to 3799, MA3279 to 3281 and NASM214850 ect. are available, too. Compatibility cannot be guaranteed, so it is always recommended to test from case to case.

Screw property class

tensile strength of mounting material	screw property class							
	4.6	5.6	6.6	8.8	9.8	10.9	12.9	14.9
< 100 N/mm ²	1,5 D	1,5 D	2,0 D	2,5 D	3,0 D			
100 - 150 N/mm ²	1,5 D	1,5 D	2,0 D	2,0 D	2,5 D	2,5 D	2,5 D	3,0 D
150 - 200 N/mm ²	1,0 D	1,5 D	1,5 D	1,5 D	2,0 D	2,0 D	2,5 D	2,5 D
200 - 250 N/mm ²	1,0 D	1,0 D	1,5 D	1,5 D	1,5 D	2,0 D	2,5 D	2,5 D
250 - 300 N/mm ²	1,0 D	1,0 D	1,0 D	1,0 D	1,5 D	1,5 D	2,0 D	2,0 D
300 - 350 N/mm ²	1,0 D	1,0 D	1,0 D	1,0 D	1,5 D	1,5 D	1,5 D	2,0 D
350 - 400 N/mm ²	1,0 D	1,0 D	1,0 D	1,0 D	1,0 D	1,5 D	1,5 D	1,5 D
> 400 N/mm ²	1,0 D	1,0 D	1,0 D	1,0 D	1,0 D	1,5 D	1,5 D	1,5 D

Temperature limits for validity: aluminium alloys max. 300°C, magnesium alloys max. 100°C. For design of screwed connections under thermal stress, the changes of temperature-department material parameters must be taken into account. Intermediate lengths are available, too. For these guide values, the screw is the weaker joint member. Lengths can be shorter than recommended nominal lengths if tests confirm this.

Locking Torque for BaerCoil® Wire Thread Inserts - type: „screw grip“

thread dimension	max. locking torque [Nm]	min. locking torque 15 th cycle [Nm]	thread dimension	max. locking torque [Nm]	min. locking torque 15 th cycle
M 2 x 0.4	0.12	0,003	UNC 2 x 56	20 oz-in	3 oz-in
M 2.2 x 0.45	0.14	0.02	UNC 3 x 48	32 oz-in	7 oz-in
M 2.5 x 0.45	0.22	0.06	UNC 4 x 40	48 oz-in	10 oz-in
M 3 x 0.5	0.44	0.1	UNC 5 x 40	75 oz-in	13 oz-in
M 3.5 x 0.6	0.68	0.12	UNC 6 x 32	6 lb-in	1 lb-in
M 4 x 0.7	0.9	0.16	UNC 8 x 32	9 lb-in	1.5 lb-in
M 5 x 0.8	1.6	0.3	UNC 10 x 24	13 lb-in	2 lb-in
M 6 x 1.0	3	0.4	UNC 12 x 24	24 lb-in	3 lb-in
M 7 x 1.0	4.4	0.6	UNC 1/4 x 20	30 lb-in	4.5 lb-in
M 8 x 1.25	6	0.8	UNC 5/16 x 18	60 lb-in	7.5 lb-in
M 10 x 1.5	10	1.4	UNC 3/8 x 16	80 lb-in	12 lb-in
M 12 x 1.75	15	2.2	UNC 7/16 x 14	100 lb-in	16.5 lb-in
M 14 x 2.0	23	3	UNC 1/2 x 13	150 lb-in	24 lb-in
M 16 x 2.0	32	4.2	UNC 9/16 x 12	200 lb-in	30 lb-in
M 18 x 2.5	42	5.5	UNC 5/8 x 11	300 lb-in	40 lb-in
M 20 x 2.5	54	7	UNC 3/4 x 10	400 lb-in	60 lb-in
M 22 x 2.5	70	9	UNC 7/8 x 9	600 lb-in	82 lb-in
M 24 x 3.0	80	11	UNC 1" x 8	800 lb-in	110 lb-in
M 27 x 3.0	95	12	UNC 1.1/8" x 7	900 lb-in	137 lb-in
M 30 x 3.5	110	14	UNC 1.1/4" x 7	1000 lb-in	165 lb-in
M 33 x 3.5	125	16	UNC 1.3/8" x 6	1150 lb-in	185 lb-in
M 36 x 4.0	140	18	UNC 1.1/2" x 6	1350 lb-in	210 lb-in

BaerCoil® Thread Inserts - type: „screw grip“ (screw locking) are red colored
Please find them on page 15

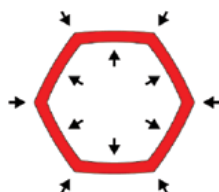



Installation by hand

1. Drilling

Clear the damaged thread with a standard drill bit. To repair a spark plug thread no pre-drilling is necessary if using the special spark plug tap with pilot nose. Optionally you can countersink the borehole.

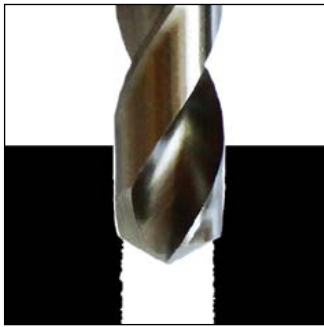

2. Tapping

Use the special BaerCoil® tap for cutting the holding thread into the cleared hole. BaerCoil® taps are suitable for blind- and through holes. It's recommended to use a suitable cutting oil.



3. Installing thread inserts

Place insert on installing tool and position the adjustable ring that the insert tang is centred in the tang slot. Wind insert in with light downward pressure until 1/4 to 1/2 turn below the surface. Do not turn against direction of rotation, because the tang can break.

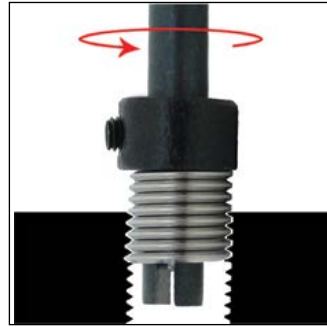

4. Tang removal

Lift the inserting tool from tang and place the tang break tool over the tang and tap down sharply. For bigger sizes and spark plug use a long nose pliers to remove the tang.



Installation by machine or electronic screwdriver

1. Drilling

Clear the damaged thread with a standard drill bit. Optionally you can countersink the borehole.



2. Tapping

Use the special BaerCoil® tap for cutting the holding thread into the cleared hole. BaerCoil® taps and forming taps are suitable for blind- and through holes. It's recommended to use a suitable cutting oil or emulsion.



3. Installing thread inserts

Position the work piece that bore and machine spindle are above each other. Set the counter nuts according the installation length (1/4 to 1/2 turn below the surface). Turn the thread insert onto the installation tool. Activate the machine so that the thread insert is screwed to the desired depth. After inserting screw the tool of the insert. Avoid any rough placement of the tool on the work piece so as to not damage the work piece, tool or thread insert.

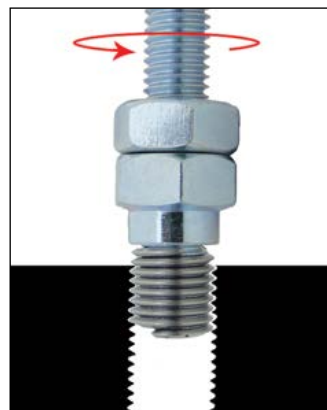

4. Tang removal

Place the tang break tool over the tang and tap down sharply or work with a pneumatic tang break tool. For bigger sizes and spark plug use a long nose pliers to remove the tang. For bulk production automatic tang breaking tools are available, too.

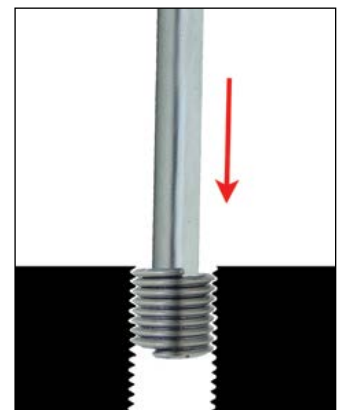

BaerCoil® Wire Thread Inserts - type: "screw grip" - material: 304 stainless steel

DIN 8140 with reduced diameter for better installation

Tolerance ISO 2 (6H)

M



Diameter x Pitch	pack. unit	1,0 D 1,0 x Diameter		1,5 D 1,5 x Diameter		2,0 D 2,0 x Diameter		2,5 D 2,5 x Diameter		3,0 D 3,0 x Diameter	
		Item-No.:	Price per unit	Item-No.:	Price per unit	Item-No.:	Price per unit	Item-No.:	Price per unit	Item-No.:	Price per unit
M 2 x 0,4	100	1-B6102-1	*	1-B6102-15	*	1-B6102-2	*	1-B6102-25	*	1-B6102-3	*
M 2,2 x 0,45	100	1-B6125-1	20,75 €¹	1-B6125-15	22,61 €¹	1-B6125-2	27,58 €¹	1-B6125-25	28,94 €¹	1-B6125-3	32,81 €¹
M 2,5 x 0,45	100	1-B6126-1	*	1-B6126-15	*	1-B6126-2	*	1-B6126-25	*	1-B6126-3	*
M 3 x 0,5	100	1-B6103-1	20,18 €	1-B6103-15	14,96 €	1-B6103-2	16,85 €	1-B6103-25	19,13 €	1-B6103-3	*
	10	2-B6103-1	7,07 €	2-B6103-15	5,69 €	2-B6103-2	6,41 €	2-B6103-25	*	2-B6103-3	*
M 3,5 x 0,6	100	1-B6135-1	11,85 €¹	1-B6135-15	14,50 €¹	1-B6135-2	17,21 €¹	1-B6135-25	20,34 €¹	1-B6135-3	23,54 €¹
	100	1-B6104-1	14,90 €	1-B6104-15	21,49 €	1-B6104-2	28,63 €	1-B6104-25	22,19 €	1-B6104-3	22,66 €
M 4 x 0,7	10	2-B6104-1	5,67 €	2-B6104-15	7,52 €	2-B6104-2	10,02 €	2-B6104-25	7,77 €	2-B6104-3	7,93 €
	100	1-B6105-1	13,25 €	1-B6105-15	18,83 €	1-B6105-2	17,31 €	1-B6105-25	20,50 €	1-B6105-3	24,36 €
M 5 x 0,8	10	2-B6105-1	5,25 €	2-B6105-15	6,59 €	2-B6105-2	6,23 €	2-B6105-25	7,62 €	2-B6105-3	8,45 €
	100	1-B6106-1	23,18 €	1-B6106-15	17,31 €	1-B6106-2	27,81 €	1-B6106-25	25,90 €	1-B6106-3	27,52 €
M 6 x 1,0	10	2-B6106-1	8,03 €	2-B6106-15	5,67 €	2-B6106-2	9,06 €	2-B6106-25	7,90 €	2-B6106-3	8,14 €
	100	1-B6107-1	21,14 €	1-B6107-15	28,05 €	1-B6107-2	36,27 €	1-B6107-25	45,08 €	1-B6107-3	53,14 €
M 7 x 1,0	10	2-B6107-1	6,39 €	2-B6107-15	7,75 €	2-B6107-2	9,34 €	2-B6107-25	11,06 €	2-B6107-3	12,63 €
	100	1-B6181-1	21,19 €	1-B6181-15	28,08 €	1-B6181-2	36,28 €	1-B6181-25	44,38 €	1-B6181-3	48,78 €
M 8 x 1,0	10	2-B6181-1	6,39 €	2-B6181-15	7,75 €	2-B6181-2	9,34 €	2-B6181-25	11,06 €	2-B6181-3	12,63 €
	100	1-B6108-1	21,19 €	1-B6108-15	28,08 €	1-B6108-2	36,28 €	1-B6108-25	48,78 €	1-B6108-3	47,82 €
M 8 x 1,25	10	2-B6108-1	6,39 €	2-B6108-15	7,75 €	2-B6108-2	9,34 €	2-B6108-25	11,06 €	2-B6108-3	12,63 €
	100	1-B6101-1	28,99 €	1-B6101-15	41,95 €	1-B6101-2	54,41 €	1-B6101-25	66,53 €	1-B6101-3	78,84 €
M 10 x 1,25	10	2-B6101-1	7,76 €	2-B6101-15	10,29 €	2-B6101-2	12,71 €	2-B6101-25	15,08 €	2-B6101-3	17,47 €
	100	1-B6110-1	28,99 €	1-B6110-15	41,95 €	1-B6110-2	54,41 €	1-B6110-25	71,94 €	1-B6110-3	78,84 €
M 10 x 1,5	10	2-B6110-1	7,76 €	2-B6110-15	10,29 €	2-B6110-2	12,71 €	2-B6110-25	16,28 €	2-B6110-3	17,47 €
	100			1-B6112-15	58,49 €	1-B6112-2	78,06 €	1-B6112-25	97,14 €		
M 12 x 1,25	100			1-B6115-15	60,82 €	1-B6115-2	80,53 €				
	100	1-B6127-1	43,00 €	1-B6127-15	58,29 €	1-B6127-2	84,32 €	1-B6127-25	104,72 €	1-B6127-3	115,58 €
M 12 x 1,5	10	2-B6127-1	10,65 €	2-B6127-15	13,51 €	2-B6127-2	18,72 €	2-B6127-25	22,68 €	2-B6127-3	24,93 €
	50	1-B6114-1	31,79 €	1-B6114-15	47,46 €	1-B6114-2	63,52 €	1-B6114-25	99,49 €	1-B6114-3	114,26 €
M 14 x 2,0	10	2-B6114-1	13,86 €	2-B6114-15	20,80 €	2-B6114-2	27,06 €	2-B6114-25	39,48 €		
	50	1-B6116-1	38,15 €	1-B6116-15	61,32 €	1-B6116-2	119,81 €	1-B6116-25	123,49 €	1-B6116-3	153,96 €
M 16 x 2,0	10	2-B6116-1	16,97 €	2-B6116-15	25,21 €			2-B6116-25	50,43 €		
	25	1-B6119-1	39,57 €	1-B6119-15	60,05 €						
M 18 x 2,5	10	2-B6119-1	30,70 €	2-B6119-15	45,48 €						
	25	1-B6120-1	185,75 €	1-B6120-15	191,21 €	1-B6120-2	344,17 €				
M 20 x 1,5	25	1-BS7240-1	43,78 €	1-BS7240-15	74,82 €	1-BS7240-2	95,73 €	1-BS7240-25	120,93 €		
	10	2-BS7240-1	36,26 €	2-BS7240-15	60,46 €	2-BS7240-2	76,77 €	2-BS7240-25	96,43 €		
M 24 x 2,0	25					1-BS7246-2	77,43 €				
	10					2-BS7246-2	62,50 €				
M 24 x 3,0	25	1-BS7245-1	84,34 €	1-BS7245-15	126,34 €	1-BS7245-2	166,96 €	1-BS7245-25	409,73 €		
	10	2-BS7245-1	67,88 €	2-BS7245-15	47,28 €	2-BS7245-2	132,33 €				
M 30 x 3,5	5	1-BS7354-1	30,60 €	1-BS7354-15	46,50 €	1-BS7354-2	71,09 €				
M 36 x 4,0	5			1-BES364-15	84,08 €	1-BES364-2	112,39 €				

* on request
¹ prices only available for remainder of stock

BaerCoil® Wire Thread Inserts - type: "screw grip"

In addition to "free-running" insert characteristics, BaerCoil® "screw grip" thread inserts have one or more polygon-formed windings, which have a clamping effect on the flanks of the inserted screw. We only recommend using screws with a higher screw property class (from 8.8 on), because of this screw locking or screw clamping effect. An elastic and flexible frictional connection is formed. The clamping torque is comparable to the indications in DIN 267 Part 15 and ISO 2320. BaerCoil® "screw grip" thread inserts are predominantly used in areas where screw connections must remain tight while exposed to tremors, constant vibrations and movements. Screw grip inserts are red-colored.

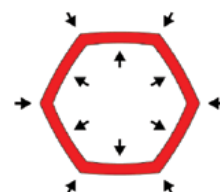

i see locking torque on page 7



BaerCoil® Wire Thread Inserts - type: "screw grip" - material: stainless steel 304

UNC

Diameter x Threads per inch	pack. unit	1,0 D 1,0 x Diameter		1,5 D 1,5 x Diameter		2,0 D 2,0 x Diameter		2,5 D 2,5 x Diameter		3,0 D 3,0 x Diameter	
		Item-No.:	Price per unit	Item-No.:	Price per unit	Item-No.:	Price per unit	Item-No.:	Price per unit	Item-No.:	Price per unit
UNC 2 x 56	100			1-B6200-15	52,53 €	1-B6200-2	52,53 €	1-B6200-25	65,66 €		
UNC 4 x 40	100	1-B6201-1	11,15 €	1-B6201-15	47,28 €	1-B6201-2	48,33 €	1-B6201-25	52,53 €	1-B6201-3	57,78 €
UNC 6 x 32	100	1-B6203-1	13,15 €	1-B6203-15	14,11 €	1-B6203-2	17,30 €	1-B6203-25	47,28 €	1-B6203-3	52,53 €
UNC 8 x 32	100	1-B6204-1	36,77 €	1-B6204-15	36,77 €	1-B6204-2	36,77 €	1-B6204-25	42,02 €	1-B6204-3	47,28 €
UNC 10 x 24	100			1-B6205-15	57,78 €	1-B6205-2	57,78 €	1-B6205-25	63,04 €	1-B6205-3	68,29 €
UNC 1/4 x 20	100	1-B6207-1	47,28 €	1-B6207-15	22,54 €	1-B6207-2	57,78 €	1-B6207-25	33,23 €	1-B6207-3	84,05 €
UNC 5/16 x 18	100	1-B6208-1	57,78 €	1-B6208-15	34,50 €	1-B6208-2	78,80 €	1-B6208-25	54,65 €	1-B6208-3	126,07 €
UNC 3/8 x 16	100	1-B6209-1	57,78 €	1-B6209-15	46,14 €	1-B6209-2	78,80 €	1-B6209-25	105,06 €	1-B6209-3	126,07 €
UNC 7/16 x 14	100	1-B6210-1	131,33 €	1-B6210-15	136,58 €	1-B6210-2	136,58 €	1-B6210-25	173,35 €	1-B6210-3	194,36 €
UNC 1/2 x 13	100	1-B6211-1	131,33 €	1-B6211-15	136,58 €	1-B6211-2	141,83 €	1-B6211-25	189,11 €	1-B6211-3	225,88 €
UNC 5/8 x 11	50	1-B6214-1	99,81 €	1-B6214-15	105,06 €	1-B6214-2	115,57 €	1-B6214-25	136,58 €	1-B6214-3	210,12 €
UNC 3/4 x 10	25	1-B6216-1	53,84 €	1-B6216-15	70,92 €	1-B6216-2	85,36 €				
UNC 7/8 x 9	10	1-B6218-1	46,75 €	1-B6218-15	60,41 €	1-B6218-2	75,12 €				
UNC 1" x 8	10	1-B6219-1	61,99 €	1-B6219-15	82,47 €	1-B6219-2	111,89 €	1-B6219-25	139,20 €		

UNF

Diameter x Threads per inch	pack. unit	1,0 D 1,0 x Diameter		1,5 D 1,5 x Diameter		2,0 D 2,0 x Diameter		2,5 D 2,5 x Diameter		3,0 D 3,0 x Diameter	
		Item-No.:	Price per unit	Item-No.:	Price per unit	Item-No.:	Price per unit	Item-No.:	Price per unit	Item-No.:	Price per unit
UNF 6 x 40	100	1-B6291-1	47,28 €	1-B6291-15	50,43 €	1-B6291-2	55,68 €			1-B6291-3	68,29 €
UNF 8 x 36	100	1-B6292-1	91,40 €	1-B6292-15	97,71 €	1-B6292-2	100,86 €	1-B6292-25	113,46 €		
UNF 10 x 32	100	1-B6293-1	36,77 €	1-B6293-15	42,02 €	1-B6293-2	47,28 €	1-B6293-25	50,43 €	1-B6293-3	57,78 €
UNF 1/4 x 28	100	1-B6225-1	47,28 €	1-B6225-15	20,14 €	1-B6225-2	25,03 €	1-B6225-25	29,52 €	1-B6225-3	78,80 €
UNF 5/16 x 24	100	1-B6226-1	42,02 €	1-B6226-15	26,78 €	1-B6226-2	57,78 €	1-B6226-25	73,54 €	1-B6226-3	131,33 €
UNF 3/8 x 24	100	1-B6227-1	52,53 €	1-B6227-15	29,77 €	1-B6227-2	68,29 €	1-B6227-25	51,69 €		
UNF 7/16 x 20	100	1-B6228-1	63,04 €	1-B6228-15	46,90 €	1-B6228-2	78,80 €	1-B6228-25	74,83 €	1-B6228-3	147,08 €
UNF 1/2 x 20	100			1-B6229-15	54,11 €	1-B6229-2	99,81 €	1-B6229-25	131,33 €	1-B6229-3	157,59 €
UNF 9/16 x 18	50	1-B6230-1	57,78 €	1-B6230-15	63,04 €	1-B6230-2	70,92 €				
UNF 5/8 x 18	50	1-B6231-1	65,66 €	1-B6231-15	73,54 €	1-B6231-2	89,30 €	1-B6231-25	131,33 €	1-B6231-3	173,35 €
UNF 3/4 x 16	25	1-B6233-1	59,10 €	1-B6233-15	61,72 €	1-B6233-2	68,29 €	1-B6233-25	114,25 €	1-B6233-3	127,39 €
UNF 7/8 x 14	10	1-B6235-1	49,90 €	1-B6235-15	52,00 €	1-B6235-2	75,12 €				
UNF 1" x 12	10	1-B6237-1	56,21 €	1-B6237-15	64,09 €	1-B6237-2	74,07 €				

Harley-Davidson

Diameter x Threads per inch	pack. unit	1,0 D 1,0 x Diameter		1,5 D 1,5 x Diameter		2,0 D 2,0 x Diameter		2,5 D 2,5 x Diameter		3,0 D 3,0 x Diameter	
		Item-No.:	Price per unit	Item-No.:	Price per unit	Item-No.:	Price per unit	Item-No.:	Price per unit	Item-No.:	Price per unit
1/4 x 24	10			2-B6305-15	5,88 €						
7/16 x 16	10			2-B6308-15	8,83 €						

BA

Diameter	pack. unit	1,0 D 1,0 x Diameter		1,5 D 1,5 x Diameter		2,0 D 2,0 x Diameter		2,5 D 2,5 x Diameter		3,0 D 3,0 x Diameter	
		Item-No.:	Price per unit	Item-No.:	Price per unit	Item-No.:	Price per unit	Item-No.:	Price per unit	Item-No.:	Price per unit
BA 0	100	1-B6470-1	34,91 €	1-B6470-15	45,41 €	1-B6470-2	54,48 €	1-B6470-25	66,59 €	1-B6470-3	77,01 €
BA 2	100	1-B6471-1	35,83 €	1-B6471-15	42,16 €	1-B6471-2	51,81 €	1-B6471-25	58,14 €	1-B6471-3	66,94 €
BA 3	100			1-B6472-15	35,69 €						
BA 4	100	1-B6473-1	33,58 €	1-B6473-15	36,11 €	1-B6473-2	43,85 €	1-B6473-25	46,81 €	1-B6473-3	52,79 €
BA 6	100	1-B6474-1	28,23 €	1-B6474-15	30,55 €	1-B6474-2	36,60 €	1-B6474-25	38,15 €	1-B6474-3	42,86 €

BaerCoil® Wire Thread Inserts - type: "screw grip" - material: stainless steel 304

BSW

Diameter x Threads per inch	pack. unit	1,0 D 1,0 x Diameter		1,5 D 1,5 x Diameter		2,0 D 2,0 x Diameter		2,5 D 2,5 x Diameter		3,0 D 3,0 x Diameter	
		Item-No.:	Price per unit	Item-No.:	Price per unit	Item-No.:	Price per unit	Item-No.:	Price per unit	Item-No.:	Price per unit
BSW 3/16 x 24	100			1-B6242-15	36,77 €	1-B6242-2	47,28 €	1-B6242-25	52,53 €	1-B6242-3	57,78 €
BSW 1/4 x 20	100			1-B6243-15	44,55 €	1-B6243-2	57,31 €	1-B6243-25	67,40 €	1-B6243-3	79,06 €
BSW 5/16 x 18	100	1-B6244-1	48,75 €	1-B6244-15	70,13 €	1-B6244-2	91,09 €	1-B6244-25	111,26 €	1-B6244-3	133,01 €
BSW 3/8 x 16	100	1-B6245-1	60,20 €	1-B6245-15	86,78 €	1-B6245-2	113,46 €				
BSW 7/16 x 14	100			1-B6246-15	97,13 €	1-B6246-2	146,98 €	1-B6246-25	195,62 €		
BSW 1/2 x 12	100	1-B6247-1	214,06 €	1-B6247-15	326,32 €	1-B6247-2	435,32 €	1-B6247-25	547,42 €	1-B6247-3	691,72 €
BSW 5/8 x 11	50	1-B6249-1	182,80 €								

BSF

Diameter x Threads per inch	pack. unit	1,0 D 1,0 x Diameter		1,5 D 1,5 x Diameter		2,0 D 2,0 x Diameter		2,5 D 2,5 x Diameter		3,0 D 3,0 x Diameter	
		Item-No.:	Price per unit	Item-No.:	Price per unit	Item-No.:	Price per unit	Item-No.:	Price per unit	Item-No.:	Price per unit
BSF 1/4 x 26	100	1-B6263-1	47,70 €	1-B6263-15	62,09 €	1-B6263-2	75,38 €	1-B6263-25	89,30 €	1-B6263-3	103,33 €
BSF 5/16 x 22	100	1-B6265-1	67,03 €	1-B6265-15	94,45 €	1-B6265-2	120,29 €	1-B6265-25	148,19 €	1-B6265-3	183,86 €
BSF 3/8 x 20	100	1-B6266-1	90,40 €	1-B6266-15	130,12 €	1-B6266-2	168,36 €	1-B6266-25	210,12 €	1-B6266-3	249,89 €
BSF 7/16 x 18	100	1-B6267-1	168,10 €	1-B6267-15	193,05 €	1-B6267-2	253,77 €	1-B6267-25	325,69 €		
BSF 1/2 x 16	100	1-B6268-1	145,46 €	1-B6268-15	217,16 €	1-B6268-2	287,39 €	1-B6268-25	358,20 €		
BSF 9/16 x 16	50	1-B6269-1	106,01 €	1-B6269-15	157,91 €						
BSF 5/8 x 14	50	1-B6270-1	151,08 €	1-B6270-15	226,30 €	1-B6270-2	302,31 €				
BSF 3/4 x 12	25	1-B6272-1	219,10 €	1-B6272-15	267,54 €	1-B6272-3	518,52 €				
BSF 7/8 x 11	10			1-B6274-15	131,33 €						
BSF 1" x 10	10			1-B6276-15	176,34 €	1-B6276-2	234,39 €				

BaerCoil® Wire Thread Inserts on strip feed type: "screw grip" - material: stainless steel 304

BaerCoil® Wire Thread Inserts on strip feed are especially used in the bulk production to speed up the inserting process.



M

Diameter x pitch	1,0 D 1,0 x Diameter		1,5 D 1,5 x Diameter		2,0 D 1,5 x Diameter	
	Item-No.:		Item-No.:		Item-No.:	
M 3 x 0,5	B6103-1MAG		B6103-15MAG		B6103-25MAG	
M 4 x 0,7	B6104-1MAG		B6104-15MAG		B6104-25MAG	
M 5 x 0,8	B6105-1MAG		B6105-15MAG		B6105-25MAG	
M 6 x 1,0	B6106-1MAG		B6106-15MAG		B6106-25MAG	
M 8 x 1,25	B6108-1MAG		B6108-15MAG		B6108-25MAG	
M 10 x 1,5	B7215-1MAG		B7215-15MAG		B7215-2MAG	

Please inquire prices, quantities and other dimensions.

You can find more information to our screw locking BaerCoil® Wire Thread Inserts type: "screw grip" from page 4 - 7.

BaerCoil® Metric Wire Thread Inserts for aerospace industry

type: „LN 9039“ - free running - material: stainless steel 304

delivery time & prices on request

LN stand. = Item-No	LN stand. = Item-No	LN stand. = Item-No	LN stand. = Item-No	LN stand. = Item-No	LN stand. = Item-No
LN9039-00025	LN9039-04120	LN9039-08200	LN9039-12360	LN9039-16480	LN9039-20540
LN9039-00037	LN9039-04150	LN9039-09100	LN9039-13120	LN9039-17160	LN9039-21200
LN9039-00050	LN9039-04180	LN9039-09150	LN9039-13180	LN9039-17240	LN9039-21300
LN9039-01030	LN9039-05070	LN9039-09200	LN9039-13240	LN9039-17320	LN9039-21400
LN9039-01045	LN9039-05105	LN9039-10100	LN9039-14140	LN9039-18180	LN9039-22200
LN9039-01060	LN9039-05140	LN9039-10150	LN9039-14210	LN9039-18270	LN9039-22300
LN9039-02040	LN9039-06080	LN9039-10200	LN9039-14280	LN9039-18360	LN9039-22400
LN9039-02060	LN9039-06120	LN9039-10250	LN9039-14350	LN9039-18450	LN9039-23200
LN9039-02080	LN9039-06160	LN9039-10300	LN9039-14420	LN9039-18540	LN9039-23300
LN9039-03050	LN9039-07080	LN9039-11120	LN9039-15140	LN9039-19180	LN9039-23400
LN9039-03075	LN9039-07120	LN9039-11180	LN9039-15210	LN9039-19270	LN9499-23300
LN9039-03100	LN9039-07160	LN9039-11240	LN9039-15280	LN9039-19360	LN9499-23400
LN9039-03125	LN9039-07200	LN9039-12120	LN9039-16160	LN9039-20180	
LN9039-03150	LN9039-07240	LN9039-12180	LN9039-16240	LN9039-20270	
LN9039-04060	LN9039-08100	LN9039-12240	LN9039-16320	LN9039-20360	
LN9039-04090	LN9039-08150	LN9039-12300	LN9039-16400	LN9039-20450	

BaerCoil® Metric Wire Thread Inserts for aerospace industry

type: „LN 9499-1“ - „screw grip“ - material: stainless steel 304

delivery time & prices on request

LN stand. = Item-No	LN stand. = Item-No	LN stand. = Item-No	LN stand. = Item-No	LN stand. = Item-No	LN stand. = Item-No
LN9499-00025	LN9499-04060	LN9499-08100	LN9499-12240	LN9499-16320	LN9499-20360
LN9499-00037	LN9499-04090	LN9499-08150	LN9499-12300	LN9499-16400	LN9499-20450
LN9499-00050	LN9499-04120	LN9499-08200	LN9499-12360	LN9499-16480	LN9499-20540
LN9499-01030	LN9499-04150	LN9499-09100	LN9499-13120	LN9499-17160	LN9499-21200
LN9499-01045	LN9499-04180	LN9499-09150	LN9499-13180	LN9499-17240	LN9499-21300
LN9499-01060	LN9499-05070	LN9499-09200	LN9499-13240	LN9499-17320	LN9499-21400
LN9499-02040	LN9499-05105	LN9499-10100	LN9499-14140	LN9499-18180	LN9499-22200
LN9499-02060	LN9499-05140	LN9499-10150	LN9499-14210	LN9499-18270	LN9499-22300
LN9499-02080	LN9499-06080	LN9499-10200	LN9499-14280	LN9499-18360	LN9499-22400
LN9499-02100	LN9499-06120	LN9499-10250	LN9499-14350	LN9499-18450	LN9499-23200
LN9499-02120	LN9499-06160	LN9499-10300	LN9499-14420	LN9499-18540	LN9499-23300
LN9499-03050	LN9499-07080	LN9499-11120	LN9499-15140	LN9499-19180	LN9499-23400
LN9499-03075	LN9499-07120	LN9499-11180	LN9499-15210	LN9499-19270	
LN9499-03100	LN9499-07160	LN9499-11240	LN9499-15280	LN9499-19360	
LN9499-03125	LN9499-07200	LN9499-12120	LN9499-16160	LN9499-20180	
LN9499-03150	LN9499-07240	LN9499-12180	LN9499-16240	LN9499-20270	

BaerCoil® Metric Wire Thread Inserts for aerospace industry

type: „DIN65536“ - „screw grip“ - material: bronze CuSn6

delivery time & prices on request

Non-magnetic bronze inserts with best electric conductivity

DIN stand. = Item-No	DIN stand. = Item-No	DIN stand. = Item-No	DIN stand. = Item-No	DIN stand. = Item-No	DIN stand. = Item-No
DIN65536-01 025 A	DIN65536-03 040 A	DIN65536-05 060 A	DIN65536-07 080 A	DIN65536-09 100 A	DIN65536-11 120 A
DIN65536-01 037 A	DIN65536-03 060 A	DIN65536-05 090 A	DIN65536-07 120 A	DIN65536-09 150 A	DIN65536-11 180 A
DIN65536-01 050 A	DIN65536-03 080 A	DIN65536-05 120 A	DIN65536-07 160 A	DIN65536-09 200 A	DIN65536-11 240 A
DIN65536-02 030 A	DIN65536-04 050 A	DIN65536-06 080 A	DIN65536-08 100 A	DIN65536-10 120 A	
DIN65536-02 045 A	DIN65536-04 075 A	DIN65536-06 120 A	DIN65536-08 150 A	DIN65536-10 180 A	
DIN65536-02 060 A	DIN65536-04 100 A	DIN65536-06 160 A	DIN65536-08 200 A	DIN65536-10 240 A	



BaerCoil® Tangless® CoilThread® Wire Thread Inserts



BaerCoil® Tangless® CoilThread® Wire Thread Inserts - type: „free running“

material: stainless steel 304 delivery time: on request Inserting tools: on request

M

Diameter x Pitch	pack. unit	1,0 D		1,5 D		2,0 D		2,5 D		3,0 D	
		1,0 x Diameter		1,5 x Diameter		2,0 x Diameter		2,5 x Diameter		3,0 x Diameter	
		Item-No.:	Price per unit	Item-No.:	Price per unit	Item-No.:	Price per unit	Item-No.:	Price per unit	Item-No.:	Price per unit
M 2 x 0,4	1.000	1-B7202-1TL	508,41 €	1-B7202-15TL	519,62 €	1-B7202-2TL	530,83 €				
M 2,5 x 0,45	1.000	1-B7204-1TL	344,94 €	1-B7204-15TL	348,50 €	1-B7204-2TL	353,87 €	1-B7204-25TL	358,33 €	1-B7204-3TL	362,79 €
M 3 x 0,5	1.000	1-B7205-1TL	347,92 €	1-B7205-15TL	353,76 €	1-B7205-2TL	362,63 €	1-B7205-25TL	370,02 €	1-B7205-3TL	377,40 €
M 4 x 0,7	1.000	1-B7207-1TL	356,95 €	1-B7207-15TL	369,43 €	1-B7207-2TL	381,60 €	1-B7207-25TL	391,00 €	1-B7207-3TL	406,30 €
M 5 x 0,8	1.000	1-B7208-1TL	357,37 €	1-B7208-15TL	374,05 €	1-B7208-2TL	393,60 €	1-B7208-25TL	411,77 €	1-B7208-3TL	429,83 €
M 6 x 1,0	1.000	1-B7209-1TL	369,80 €	1-B7209-15TL	398,54 €	1-B7209-2TL	426,28 €	1-B7209-25TL	454,43 €	1-B7209-3TL	482,75 €
M 8 x 1,25	1.000	1-B7211-1TL	373,04 €	1-B7211-15TL	420,27 €	1-B7211-2TL	466,17 €	1-B7211-25TL	512,71 €	1-B7211-3TL	559,30 €
M 10 x 1,5	1.000	1-B7215-1TL	396,21 €	1-B7215-15TL	474,30 €	1-B7215-2TL	542,30 €	1-B7215-25TL	610,25 €	1-B7215-3TL	688,34 €
M 12 x 1,75	1.000	1-B7221-1TL	485,83 €	1-B7221-15TL	600,47 €	1-B7221-2TL	714,90 €	1-B7221-25TL	829,39 €	1-B7221-3TL	943,82 €

UNC

Diameter x Threads per inch	pack. unit	1,0 D		1,5 D		2,0 D		2,5 D		3,0 D	
		1,0 x Diameter		1,5 x Diameter		2,0 x Diameter		2,5 x Diameter		3,0 x Diameter	
		Item-No.:	Price per unit	Item-No.:	Price per unit	Item-No.:	Price per unit	Item-No.:	Price per unit	Item-No.:	Price per unit
UNC 2 x 56	1.000	1-B8200-1TL	343,24 €	1-B8200-15TL	347,44 €	1-B8200-2TL	350,36 €	1-B8200-25TL	354,82 €	1-B8200-3TL	359,60 €
UNC 4 x 40	1.000	1-B8201-1TL	347,44 €	1-B8201-15TL	354,34 €	1-B8201-2TL	359,98 €	1-B8201-25TL	366,88 €	1-B8201-3TL	374,00 €
UNC 6 x 32	1.000	1-B8203-1TL	339,79 €	1-B8203-15TL	347,70 €	1-B8203-2TL	355,41 €	1-B8203-25TL	363,32 €	1-B8203-3TL	370,28 €
UNC 8 x 32	1.000	1-B8204-1TL	344,94 €	1-B8204-15TL	355,78 €	1-B8204-2TL	366,99 €	1-B8204-25TL	377,35 €	1-B8204-3TL	387,18 €
UNC 10 x 24	1.000	1-B8205-1TL	319,76 €	1-B8205-15TL	335,38 €	1-B8205-2TL	351,05 €	1-B8205-25TL	366,99 €	1-B8205-3TL	382,39 €
UNC 1/4 x 20	1.000	1-B8207-1TL	347,04 €	1-B8207-15TL	383,62 €	1-B8207-2TL	416,66 €	1-B8207-25TL	451,19 €	1-B8207-3TL	485,72 €
UNC 5/16 x 18	1.000	1-B8208-1TL	334,48 €	1-B8208-15TL	383,14 €	1-B8208-2TL	429,57 €	1-B8208-25TL	476,11 €	1-B8208-3TL	520,89 €
UNC 3/8 x 16	1.000	1-B8209-1TL	373,20 €	1-B8209-15TL	443,01 €	1-B8209-2TL	511,86 €	1-B8209-25TL	586,50 €	1-B8209-3TL	652,38 €

UNF

Diameter x Threads per inch	pack. unit	1,0 D		1,5 D		2,0 D		2,5 D		3,0 D	
		1,0 x Diameter		1,5 x Diameter		2,0 x Diameter		2,5 x Diameter		3,0 x Diameter	
		Item-No.:	Price per unit	Item-No.:	Price per unit	Item-No.:	Price per unit	Item-No.:	Price per unit	Item-No.:	Price per unit
UNF 10 x 32	1.000	1-B8293-1TL	350,41 €	1-B8293-15TL	366,08 €	1-B8293-2TL	380,48 €	1-B8293-25TL	396,10 €	1-B8293-3TL	410,55 €
UNF 1/4 x 28	1.000	1-B8225-1TL	378,78 €	1-B8225-15TL	409,28 €	1-B8225-2TL	434,83 €	1-B8225-25TL	462,93 €	1-B8225-3TL	490,98 €
UNF 5/16 x 24	1.000	1-B8226-1TL	370,28 €	1-B8226-15TL	410,66 €	1-B8226-2TL	445,08 €	1-B8226-25TL	491,73 €	1-B8226-3TL	514,57 €
UNF 3/8 x 24	1.000	1-B8227-1TL	414,22 €	1-B8227-15TL	467,77 €	1-B8227-2TL	520,68 €	1-B8227-25TL	586,18 €	1-B8227-3TL	643,13 €

BaerCoil® Tangless® CoilThread® Wire Thread Inserts - type: „screw grip“

material: stainless steel 304 delivery time: on request Inserting tools: on request

M

Diameter x Pitch	pack. unit	1,0 D		1,5 D		2,0 D		2,5 D		3,0 D	
		1,0 x Diameter		1,5 x Diameter		2,0 x Diameter		2,5 x Diameter		3,0 x Diameter	
		Item-No.:	Price per unit	Item-No.:	Price per unit	Item-No.:	Price per unit	Item-No.:	Price per unit	Item-No.:	Price per unit
M 2,5 x 0,45	1.000	1-B6126-1TL	374,80 €	1-B6126-15TL	378,36 €	1-B6126-2TL	383,72 €	1-B6126-25TL	388,18 €	1-B6126-3TL	392,65 €
M 3 x 0,5	1.000	1-B6103-1TL	377,77 €	1-B6103-15TL	383,62 €	1-B6103-2TL	392,49 €	1-B6103-25TL	399,87 €	1-B6103-3TL	407,26 €
M 4 x 0,7	1.000	1-B6104-1TL	386,80 €	1-B6104-15TL	399,29 €	1-B6104-2TL	411,45 €	1-B6104-25TL	420,86 €	1-B6104-3TL	436,16 €
M 5 x 0,8	1.000	1-B6105-1TL	387,23 €	1-B6105-15TL	403,91 €	1-B6105-2TL	423,46 €	1-B6105-25TL	441,63 €	1-B6105-3TL	459,69 €
M 6 x 1,0	1.000	1-B6106-1TL	399,66 €	1-B6106-15TL	428,40 €	1-B6106-2TL	456,13 €	1-B6106-25TL	484,29 €	1-B6106-3TL	512,60 €
M 8 x 1,25	1.000	1-B6108-1TL	420,86 €	1-B6108-15TL	468,08 €	1-B6108-2TL	513,98 €	1-B6108-25TL	560,52 €	1-B6108-3TL	607,11 €
M 10 x 1,5	1.000	1-B6110-1TL	444,02 €	1-B6110-15TL	522,11 €	1-B6110-2TL	590,11 €	1-B6110-25TL	658,06 €	1-B6110-3TL	736,15 €
M 12 x 1,75	1.000	1-B6127-1TL	533,64 €	1-B6127-15TL	648,28 €	1-B6127-2TL	762,72 €	1-B6127-25TL	877,20 €	1-B6127-3TL	991,63 €

UNC

Diameter x Threads per inch	pack. unit	1,0 D		1,5 D		2,0 D		2,5 D		3,0 D	
		1,0 x Diameter		1,5 x Diameter		2,0 x Diameter		2,5 x Diameter		3,0 x Diameter	
		Item-No.:	Price per unit	Item-No.:	Price per unit	Item-No.:	Price per unit	Item-No.:	Price per unit	Item-No.:	Price per unit
UNC 2 x 56	1.000	1-B6200-1TL	373,10 €	1-B6200-15TL	377,29 €	1-B6200-2TL	380,22 €	1-B6200-25TL	384,68 €	1-B6200-3TL	389,46 €
UNC 4 x 40	1.000	1-B6201-1TL	377,29 €	1-B6201-15TL	384,20 €	1-B6201-2TL	389,83 €	1-B6201-25TL	396,74 €	1-B6201-3TL	403,86 €
UNC 6 x 32	1.000	1-B6203-1TL	369,64 €	1-B6203-15TL	377,56 €	1-B6203-2TL	385,26 €	1-B6203-25TL	393,18 €	1-B6203-3TL	400,14 €
UNC 8 x 32	1.000	1-B6204-1TL	374,80 €	1-B6204-15TL	385,63 €	1-B6204-2TL	396,84 €	1-B6204-25TL	407,20 €	1-B6204-3TL	417,03 €
UNC 10 x 24	1.000	1-B6205-1TL	349,62 €	1-B6205-15TL	365,23 €	1-B6205-2TL	380,91 €	1-B6205-25TL	396,84 €	1-B6205-3TL	412,25 €
UNC 1/4 x 20	1.000	1-B6207-1TL	377,45 €	1-B6207-15TL	413,47 €	1-B6207-2TL	446,52 €	1-B6207-25TL	481,05 €	1-B6207-3TL	515,58 €
UNC 5/16 x 18	1.000	1-B6208-1TL	382,29 €	1-B6208-15TL	430,95 €	1-B6208-2TL	477,38 €	1-B6208-25TL	523,92 €	1-B6208-3TL	568,70 €
UNC 3/8 x 16	1.000	1-B6209-1TL	421,02 €	1-B6209-15TL	490,82 €	1-B6209-2TL	559,67 €	1-B6209-25TL	634,31 €	1-B6209-3TL	700,19 €

UNF

Diameter x Threads per inch	pack. unit	1,0 D		1,5 D		2,0 D		2,5 D		3,0 D	
		1,0 x Diameter		1,5 x Diameter		2,0 x Diameter		2,5 x Diameter		3,0 x Diameter	
		Item-No.:	Price per unit	Item-No.:	Price per unit	Item-No.:	Price per unit	Item-No.:	Price per unit	Item-No.:	Price per unit
UNF 10 x 32	1.000	1-B6293-1TL	380,27 €	1-B6293-15TL	395,94 €	1-B6293-2TL	410,34 €	1-B6293-25TL	425,96 €	1-B6293-3TL	440,41 €
UNF 1/4 x 28	1.000	1-B6225-1TL	408,64 €	1-B6225-15TL	439,13 €	1-B6225-2TL	464,68 €	1-B6225-25TL	492,79 €	1-B6225-3TL	520,84 €
UNF 5/16 x 24	1.000	1-B6226-1TL	418,09 €	1-B6226-15TL	458,47 €	1-B6226-2TL	492,89 €	1-B6226-25TL	539,54 €	1-B6226-3TL	562,38 €
UNF 3/8 x 24	1.000	1-B6227-1TL	462,03 €	1-B6227-15TL	515,58 €	1-B6227-2TL	568,49 €	1-B6227-25TL	633,99 €	1-B6227-3TL	690,94 €

BaerCoil® Technical Data



Feinwerk-Kalibras -

Größe	Werte	Werte	Werte	Werte	Werte
1	0,05	0,075	0,1	0,15	0,2
2	0,075	0,1	0,15	0,2	0,3
3	0,1	0,15	0,2	0,3	0,4
4	0,15	0,2	0,3	0,4	0,6
5	0,2	0,3	0,4	0,6	0,8
6	0,3	0,4	0,6	0,8	1,0
7	0,4	0,6	0,8	1,0	1,5
8	0,6	0,8	1,0	1,5	2,0
9	0,8	1,0	1,5	2,0	3,0
10	1,0	1,5	2,0	3,0	4,0
11	1,5	2,0	3,0	4,0	6,0
12	2,0	3,0	4,0	6,0	8,0
13	3,0	4,0	6,0	8,0	12,0
14	4,0	6,0	8,0	12,0	16,0
15	6,0	8,0	12,0	16,0	24,0
16	8,0	12,0	16,0	24,0	32,0
17	12,0	16,0	24,0	32,0	48,0
18	16,0	24,0	32,0	48,0	64,0
19	24,0	32,0	48,0	64,0	96,0
20	32,0	48,0	64,0	96,0	128,0
21	48,0	64,0	96,0	128,0	192,0
22	64,0	96,0	128,0	192,0	256,0
23	96,0	128,0	192,0	256,0	384,0
24	128,0	192,0	256,0	384,0	512,0
25	192,0	256,0	384,0	512,0	768,0
26	256,0	384,0	512,0	768,0	1024,0
27	384,0	512,0	768,0	1024,0	1536,0
28	512,0	768,0	1024,0	1536,0	2048,0
29	768,0	1024,0	1536,0	2048,0	3072,0
30	1024,0	1536,0	2048,0	3072,0	4096,0

Automatenstähle, un

Größe	Werte	Werte	Werte	Werte	Werte
1	0,05	0,075	0,1	0,15	0,2
2	0,075	0,1	0,15	0,2	0,3
3	0,1	0,15	0,2	0,3	0,4
4	0,15	0,2	0,3	0,4	0,6
5	0,2	0,3	0,4	0,6	0,8
6	0,3	0,4	0,6	0,8	1,0
7	0,4	0,6	0,8	1,0	1,5
8	0,6	0,8	1,0	1,5	2,0
9	0,8	1,0	1,5	2,0	3,0
10	1,0	1,5	2,0	3,0	4,0
11	1,5	2,0	3,0	4,0	6,0
12	2,0	3,0	4,0	6,0	8,0
13	3,0	4,0	6,0	8,0	12,0
14	4,0	6,0	8,0	12,0	16,0
15	6,0	8,0	12,0	16,0	24,0
16	8,0	12,0	16,0	24,0	32,0
17	12,0	16,0	24,0	32,0	48,0
18	16,0	24,0	32,0	48,0	64,0
19	24,0	32,0	48,0	64,0	96,0
20	32,0	48,0	64,0	96,0	128,0
21	48,0	64,0	96,0	128,0	192,0
22	64,0	96,0	128,0	192,0	256,0
23	96,0	128,0	192,0	256,0	384,0
24	128,0	192,0	256,0	384,0	512,0
25	192,0	256,0	384,0	512,0	768,0
26	256,0	384,0	512,0	768,0	1024,0
27	384,0	512,0	768,0	1024,0	1536,0
28	512,0	768,0	1024,0	1536,0	2048,0
29	768,0	1024,0	1536,0	2048,0	3072,0
30	1024,0	1536,0	2048,0	3072,0	4096,0

Automatenstähle, K1

Größe	Werte	Werte	Werte	Werte	Werte
1	0,05	0,075	0,1	0,15	0,2
2	0,075	0,1	0,15	0,2	0,3
3	0,1	0,15	0,2	0,3	0,4
4	0,15	0,2	0,3	0,4	0,6
5	0,2	0,3	0,4	0,6	0,8
6	0,3	0,4	0,6	0,8	1,0
7	0,4	0,6	0,8	1,0	1,5
8	0,6	0,8	1,0	1,5	2,0
9	0,8	1,0	1,5	2,0	3,0
10	1,0	1,5	2,0	3,0	4,0
11	1,5	2,0	3,0	4,0	6,0
12	2,0	3,0	4,0	6,0	8,0
13	3,0	4,0	6,0	8,0	12,0
14	4,0	6,0	8,0	12,0	16,0
15	6,0	8,0	12,0	16,0	24,0
16	8,0	12,0	16,0	24,0	32,0
17	12,0	16,0	24,0	32,0	48,0
18	16,0	24,0	32,0	48,0	64,0
19	24,0	32,0	48,0	64,0	96,0
20	32,0	48,0	64,0	96,0	128,0
21	48,0	64,0	96,0	128,0	192,0
22	64,0	96,0	128,0	192,0	256,0
23	96,0	128,0	192,0	256,0	384,0
24	128,0	192,0	256,0	384,0	512,0
25	192,0	256,0	384,0	512,0	768,0
26	256,0	384,0	512,0	768,0	1024,0
27	384,0	512,0	768,0	1024,0	1536,0
28	512,0	768,0	1024,0	1536,0	2048,0
29	768,0	1024,0	1536,0	2048,0	3072,0
30	1024,0	1536,0	2048,0	3072,0	4096,0

Technical Data for BaerCoil® Wire Thread Inserts

DIN 8140 with reduced diameter for better installation

M	1,0 D			1,5 D			2,0 D			2,5 D			3,0 D			F (mm)	
	T	D	B	T	D	B	T	D	B	T	D	B	T	D	B	min.	max.
M 2 x 0.4	2.00	3.80	3.40	3.00	4.80	4.40	4.00	5.80	5.40	5.00	6.80	6.40	6.00	7.80	7.40	2.48	2.70
M 2.2 x 0.45	2.20	4.23	3.78	3.30	5.33	4.88	4.40	6.43	5.98	5.50	7.53	7.08	6.60	8.63	8.18		
M 2.5 x 0.45	2.50	4.52	4.07	3.75	5.78	5.33	5.00	7.03	6.58	6.25	8.28	7.83	7.50	9.53	9.08	3.04	3.70
M 3 x 0.5	3.00	5.25	4.75	4.50	6.75	6.25	6.00	8.25	7.75	7.50	9.75	9.25	9.00	11.25	10.75	3.60	4.35
M 3.5 x 0.6	3.50	6.20	5.60	5.25	7.95	7.35	7.00	9.70	9.10	8.75	11.45	10.85	10.50	13.20	12.60	4.22	4.95
M 4 x 0.7	4.00	7.15	6.45	6.00	9.15	8.45	8.00	11.15	10.45	10.00	13.15	12.45	12.00	15.15	14.45	4.83	5.60
M 4.5 x 0.75	4.50	7.88	7.13	6.75	10.13	9.38	9.00	12.38	11.63	11.25	14.63	13.88	13.50	16.88	16.13		
M 5 x 0.8	5.00	8.60	7.80	7.50	11.10	10.30	10.00	13.60	12.80	12.50	16.10	15.30	15.00	18.60	17.80	5.94	6.80
M 6 x 1.0	6.00	10.50	9.50	9.00	13.50	12.50	12.00	16.50	15.50	15.00	19.50	18.50	18.00	22.50	21.50	7.17	7.95
M 7 x 1.0	7.00	11.50	10.50	10.50	15.00	14.00	14.00	18.50	17.50	17.50	22.00	21.00	21.00	25.50	24.50	8.17	9.20
M 8 x 1.0	8.00	12.50	11.50	12.00	16.50	15.50	16.00	20.50	19.50	20.00	24.50	23.50	24.00	28.50	27.50	9.17	10.25
M 8 x 1.25	8.00	13.63	12.38	12.00	17.63	16.38	16.00	21.63	20.38	20.00	25.63	24.38	24.00	29.63	28.38	9.45	10.35
M 9 x 1.0	9.00	13.50	12.50	13.50	18.00	17.00	18.00	22.50	21.50	22.50	27.00	26.00	27.00	31.50	30.50	10.17	11.23
M 9 x 1.25	9.00	14.63	13.38	13.50	19.13	17.88	18.00	23.63	22.38	22.50	28.13	26.88	27.00	32.63	31.38	10.45	11.16
M 10 x 1.0	10.00	14.50	13.50	15.00	19.50	18.50	20.00	24.50	23.50	25.00	29.50	28.50	30.00	34.50	33.50	11.17	12.50
M 10 x 1.25	10.00	15.63	14.38	15.00	20.63	19.38	20.00	25.63	24.38	25.00	30.63	29.38	30.00	35.63	34.38	11.45	12.65
M 10 x 1.5	10.00	16.75	15.25	15.00	21.75	20.25	20.00	26.75	25.25	25.00	31.75	30.25	30.00	36.75	35.25	11.74	12.50
M 11 x 1.25	11.00	16.62	15.37	16.50	22.12	20.87	22.00	27.62	26.37	27.50	33.12	31.87	33.00	38.62	37.37	12.47	13.76
M 11 x 1.5	11.00	17.75	16.25	16.50	23.25	21.75	22.00	28.75	27.25	27.50	34.25	32.75	33.00	39.75	38.25	12.74	13.59
M 12 x 1.25	12.00	17.63	16.38	18.00	23.63	22.38	24.00	29.63	27.38	30.00	35.63	34.38	36.00	41.63	40.38	13.47	15.00
M 12 x 1.5	12.00	18.75	17.25	18.00	24.00	23.25	24.00	30.75	29.25	30.00	36.75	35.25	36.00	42.75	41.25	13.75	15.20
M 12 x 1.75	12.00	19.88	18.13	18.00	25.88	24.13	24.00	31.88	30.13	30.00	37.88	36.13	36.00	43.88	42.13	14.03	15.00
M 14 x 1.25	14.00	19.62	18.37	21.00	26.62	25.37	28.00	33.62	32.37	35.00	40.62	39.37	42.00	47.62	46.37	15.47	17.03
M 14 x 1.5	14.00	20.75	19.25	21.00	27.75	26.25	28.00	34.75	33.25	35.00	41.75	40.25	42.00	48.75	47.25	15.75	17.25
M 14 x 2.0	14.00	23.00	21.00	21.00	30.00	28.00	28.00	37.00	35.00	35.00	44.00	42.00	42.00	51.00	49.00	16.31	17.35
M 16 x 1.5	16.00	22.75	21.25	24.00	30.75	29.25	32.00	38.75	37.25	40.00	46.75	45.25	48.00	54.75	53.25	17.75	19.60
M 16 x 2.0	16.00	25.00	23.00	24.00	33.00	31.00	32.00	41.00	39.00	40.00	49.00	47.00	48.00	57.00	55.00	18.31	19.60
M 18 x 1.5	18.00	24.75	23.25	27.00	33.75	32.25	36.00	42.75	41.25	45.00	51.75	50.25	54.00	60.75	59.25	19.75	21.85
M 18 x 2.0	18.00	27.00	25.00	27.00	36.00	34.00	36.00	45.00	43.00	45.00	54.00	52.00	54.00	63.00	61.00	20.31	21.85
M 18 x 2.5	18.00	29.25	26.75	27.00	38.25	35.75	36.00	47.25	44.75	45.00	56.25	53.75	54.00	65.25	62.75	20.86	22.00

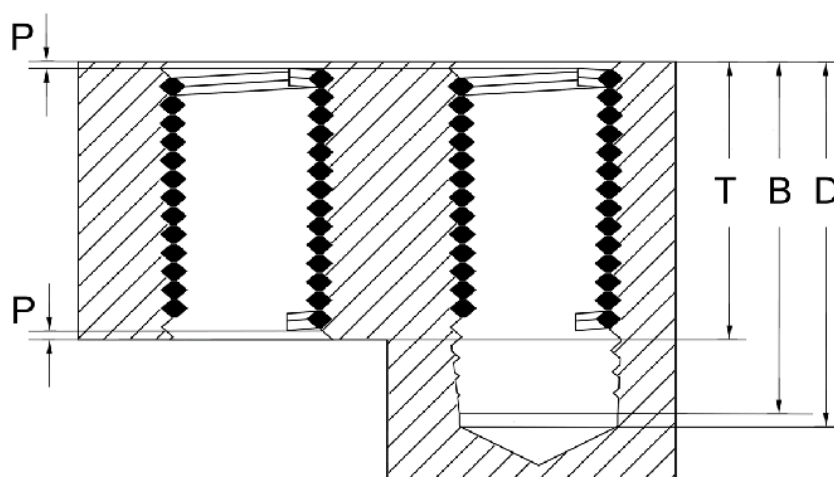
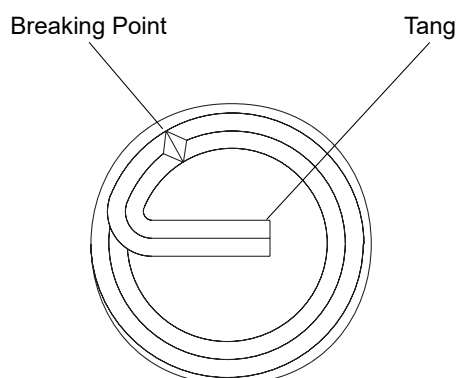

- P Installed insert 1/4 – 1/2 pitch below the surface
- T Length of Insert, when installed
- B Tap depth – including threads chamfer of plug tap
- D Drill depth (min.) - excluding point
- F Free coil diameter



Technical Data for BaerCoil® Wire Thread Inserts

M	1,0 D			1,5 D			2,0 D			2,5 D			3,0 D			F (mm)	
	T	D	B	T	D	B	T	D	B	T	D	B	T	D	B	min.	max.
M 20 x 1.5	20.00	26.75	25.25	30.00	36.75	35.25	40.00	46.75	45.25	50.00	56.75	55.25	60.00	66.75	65.25	21.75	24.00
M 20 x 2.0	20.00	29.00	27.00	30.00	39.00	37.00	40.00	49.00	47.00	50.00	59.00	57.00	60.00	69.00	67.00	22.31	24.05
M 20 x 2.5	20.00	31.25	28.75	30.00	41.25	38.75	40.00	51.25	48.75	50.00	61.25	58.75	60.00	71.25	68.75	22.86	24.40
M 22 x 1.5	22.00	28.75	27.25	33.00	39.75	38.25	44.00	50.75	49.25	55.00	61.75	60.25	66.00	72.75	71.25	23.75	26.45
M 22 x 2.0	22.00	31.00	29.00	33.00	42.00	40.00	44.00	53.00	51.00	55.00	64.00	62.00	66.00	75.00	73.00	24.31	26.50
M 22 x 2.5	22.00	33.25	30.75	33.00	44.25	41.75	44.00	55.25	52.75	55.00	66.25	63.75	66.00	77.25	74.75	24.86	26.90
M 24 x 2.0	24.00	33.00	31.00	36.00	45.00	43.00	48.00	57.00	55.00	60.00	69.00	67.00	72.00	81.00	79.00	26.32	29.10
M 24 x 3.0	24.00	37.50	34.50	36.00	49.50	46.50	48.00	61.50	58.50	60.00	73.50	70.50	72.00	85.50	82.50	27.43	29.00
M 27 x 2.0	27.00	36.00	34.00	40.50	49.50	47.50	54.00	63.00	61.00	67.50	76.50	74.50	81.00	90.00	88.00	29.32	32.30
M 27 x 3.0	27.00	40.50	37.50	40.50	54.00	51.00	54.00	67.50	64.50	67.50	81.00	78.00	81.00	94.50	91.50	30.43	32.40
M 30 x 3.0	30.00	43.50	40.50	45.00	58.50	55.50	60.00	73.50	70.50	75.00	88.50	85.50	90.00	103.50	100.50	33.43	36.10
M 30 x 3.5	30.00	45.75	42.25	45.00	60.75	57.25	60.00	75.75	72.25	75.00	90.75	87.25	90.00	105.75	102.25	33.99	35.81
M 33 x 3.5	33.00	48.75	45.25	49.50	65.25	61.75	66.00	81.75	78.25	82.50	98.25	94.75	99.00	114.75	111.25	36.99	38.80
M 36 x 3.0	36.00	49.50	46.50	54.00	67.50	64.50	72.00	85.50	82.50	90.00	103.50	100.50	108.00	121.50	118.50	39.43	42.70
M 36 x 4.0	36.00	54.00	50.00	54.00	72.00	68.00	72.00	90.00	86.00	90.00	108.00	104.00	108.00	126.00	122.00	40.54	42.67
M 39 x 4.0	39.00	57.00	53.00	58.50	76.50	72.50	78.00	96.00	92.00	97.50	115.50	111.50	117.00	135.00	131.00	43.54	45.75
M 42 x 3.0	42.00	55.50	52.50	63.00	76.50	73.50	84.00	97.50	94.50	105.00	118.50	115.50	126.00	139.50	136.50	45.43	49.00
M 42 x 4.5	42.00	62.25	57.75	63.00	83.25	78.75	84.00	104.25	99.75	105.00	125.25	120.75	126.00	146.25	141.75	47.10	49.00

G (BSP)	1,0 D			1,5 D			2,0 D			2,5 D			3,0 D			F (inch)	
	T	D	B	T	D	B	T	D	B	T	D	B	T	D	B	min.	max.
1/8 x 28	0.125	0.287	0.251	0.187	0.349	0.313	0.250	0.412	0.376	0.312	0.474	0.438	0.375	0.537	0.501	0.426	0.472
1/4 x 19	0.250	0.488	0.435	0.375	0.613	0.560	0.500	0.738	0.685	0.625	0.863	0.810	0.750	0.988	0.935	0.582	0.637
3/8 x 19	0.375	0.613	0.560	0.562	0.800	0.747	0.750	0.988	0.935	0.937	1.175	1.122	1.125	1.363	1.310	0.720	0.787
1/2 x 14	0.500	0.820	0.749	0.750	1.070	0.999	1.000	1.320	1.249	1.250	1.570	1.499	1.500	1.821	1.749	0.911	0.992
5/8 x 14	0.625	0.945	0.874	0.937	1.257	1.186	1.250	1.570	1.499	1.562	1.882	1.811	1.875	2.195	2.124	0.988	1.078
3/4 x 14	0.750	1.070	0.999	1.125	1.445	1.374	1.500	1.820	1.749	1.875	2.195	2.124	2.250	2.570	2.499	1.127	1.228
7/8 x 14	0.875	1.195	1.124	1.312	1.632	1.561	1.750	2.070	1.999	2.187	2.507	2.436	2.625	2.945	2.874	1.275	1.389
1" x 11	1.000	1.410	1.319	1.500	1.910	1.819	2.000	2.410	2.319	2.500	2.910	2.819	3.000	3.410	3.319	1.416	1.543
1.1/4" x 11	1.250	1.660	1.569	1.875	2.285	2.194	2.500	2.910	2.819	3.125	3.535	3.440	3.750	4.160	4.069	1.759	1.909
1.1/2" x 11	1.506	1.910	1.819	2.250	2.660	2.569	3.000	3.410	3.319	3.750	4.160	4.069	4.500	4.910	4.819	1.991	2.161

BA	1,0 D			1,5 D			2,0 D			2,5 D			3,0 D			F (inch)	
	T	D	B	T	D	B	T	D	B	T	D	B	T	D	B	min.	max.
BA 0	0.236	0.413	0.374	0.354	0.531	0.492	0.472	0.649	0.610	0.591	0.768	0.729	0.709	0.886	0.847	0.280	0.309
BA 1	0.209	0.368	0.333	0.313	0.472	0.437	0.417	0.567	0.541	0.522	0.681	0.646	0.626	0.785	0.750	0.248	0.273
BA 2	0.185	0.329	0.297	0.278	0.422	0.390	0.370	0.514	0.482	0.463	0.607	0.575	0.555	0.699	0.667	0.220	0.243
BA 3	0.616	0.132	0.262	0.242	0.372	0.343	0.323	0.453	0.424	0.404	0.543	0.505	0.484	0.614	0.585	0.193	0.213
BA 4	0.142	0.259	0.233	0.213	0.330	0.304	0.283	0.400	0.374	0.354	0.471	0.455	0.425	0.542	0.516	0.170	0.188
BA 5	0.126	0.230	0.207	0.189	0.293	0.270	0.252	0.356	0.333	0.315	0.419	0.396	0.378	0.482	0.459	0.152	0.167
BA 6	0.110	0.204	0.183	0.165	0.259	0.238	0.220	0.314	0.293	0.276	0.370	0.349	0.331	0.425	0.404	0.133	0.147

Technical Data for BaerCoil® Wire Thread Inserts

UNC	1,0 D			1,5 D			2,0 D			2,5 D			3,0 D			F (inch)	
	T	D	B	T	D	B	T	D	B	T	D	B	T	D	B	min.	max.
2 x 56	0.086	0.166	0.148	0.129	0.209	0.191	0.172	0.252	0.234	0.215	0.295	0.277	0.258	0.338	0.320	0.107	0.119
3 x 48	0.099	0.193	0.172	0.148	0.242	0.221	0.198	0.292	0.271	0.248	0.342	0.321	0.297	0.391	0.370	0.124	0.139
4 x 40	0.112	0.224	0.199	0.168	0.280	0.255	0.224	0.336	0.311	0.280	0.392	0.367	0.336	0.448	0.423	0.142	0.159
5 x 40	0.125	0.237	0.212	0.187	0.300	0.275	0.250	0.362	0.337	0.312	0.425	0.400	0.375	0.487	0.462	0.155	0.173
6 x 32	0.138	0.279	0.247	0.207	0.348	0.316	0.276	0.417	0.385	0.345	0.486	0.454	0.414	0.555	0.523	0.175	0.193
8 x 32	0.164	0.305	0.273	0.246	0.387	0.355	0.328	0.469	0.437	0.410	0.551	0.519	0.492	0.633	0.601	0.201	0.220
10 x 24	0.190	0.377	0.336	0.285	0.472	0.431	0.380	0.567	0.526	0.475	0.662	0.621	0.570	0.757	0.716	0.238	0.259
12 x 24	0.216	0.404	0.362	0.324	0.512	0.470	0.432	0.620	0.578	0.540	0.727	0.686	0.648	0.836	0.794	0.265	0.283
1/4 x 20	0.250	0.475	0.425	0.375	0.600	0.550	0.500	0.725	0.675	0.625	0.850	0.800	0.750	0.975	0.925	0.308	0.330
5/16 x 18	0.312	0.562	0.507	0.469	0.719	0.663	0.625	0.875	0.819	0.781	1.031	0.976	0.937	1.187	1.132	0.377	0.400
3/8 x 16	0.375	0.656	0.594	0.562	0.844	0.781	0.750	1.031	0.969	0.937	1.219	1.156	1.125	1.406	1.344	0.447	0.472
7/16 x 14	0.437	0.759	0.687	0.656	0.978	0.906	0.875	1.196	1.125	1.094	1.415	1.343	1.312	1.634	1.562	0.520	0.551
1/2 x 13	0.500	0.846	0.769	0.750	1.096	1.019	1.000	1.346	1.269	1.250	1.596	1.519	1.500	1.846	1.769	0.588	0.622
9/16 x 12	0.562	0.937	0.854	0.844	1.219	1.135	1.125	1.500	1.417	1.406	1.781	1.698	1.687	2.062	1.979	0.659	0.694
5/8 x 11	0.625	1.034	0.943	0.937	1.347	1.256	1.250	1.659	1.568	1.562	1.972	1.881	1.875	2.284	2.193	0.730	0.767
3/4 x 10	0.750	1.200	1.100	1.125	1.575	1.475	1.500	1.950	1.850	1.875	2.325	2.225	2.250	2.700	2.600	0.865	0.906
7/8 x 9	0.875	1.375	1.264	1.312	1.812	1.701	1.750	2.250	2.139	2.187	2.687	2.576	2.625	3.125	3.014	1.002	1.052
1" x 8	1.000	1.563	1.437	1.500	2.062	1.937	2.000	2.562	2.437	2.500	3.062	2.937	3.000	3.562	3.437	1.143	1.196
1.1/8" x 7	1.125	1.768	1.625	1.687	2.330	2.187	2.250	2.893	2.750	2.812	3.455	3.312	3.375	4.018	3.875	1.288	1.355
1.1/4" x 7	1.250	1.893	1.750	1.875	2.518	2.375	2.500	3.143	3.000	3.125	3.768	3.625	3.750	4.393	4.250	1.413	1.483
1.3/8" x 6	1.375	2.125	1.958	2.062	2.812	2.646	2.750	3.500	3.333	3.437	4.187	4.021	4.125	4.875	4.708	1.565	1.643
1.1/2" x 6	1.500	2.250	2.083	2.250	3.000	2.833	3.000	3.750	3.583	3.750	4.500	4.333	4.500	5.250	5.083	1.690	1.772

UNF	1,0 D			1,5 D			2,0 D			2,5 D			3,0 D			F (inch)	
	T	D	B	T	D	B	T	D	B	T	D	B	T	D	B	min.	max.
2 x 64	0.086	0.156	0.141	0.129	0.199	0.184	0.172	0.242	0.227	0.215	0.285	0.270	0.258	0.328	0.313	0.105	0.116
3 x 56	0.099	0.179	0.161	0.148	0.228	0.210	0.198	0.278	0.260	0.248	0.328	0.310	0.297	0.377	0.359	0.120	0.146
4 x 48	0.112	0.206	0.185	0.168	0.262	0.241	0.224	0.318	0.297	0.280	0.374	0.353	0.336	0.430	0.409	0.137	0.162
5 x 44	0.125	0.227	0.205	0.188	0.290	0.268	0.250	0.352	0.330	0.312	0.414	0.392	0.375	0.477	0.455	0.152	0.168
6 x 40	0.138	0.250	0.225	0.207	0.319	0.294	0.276	0.388	0.363	0.345	0.457	0.432	0.414	0.526	0.501	0.168	0.193
8 x 36	0.164	0.289	0.261	0.246	0.371	0.343	0.328	0.453	0.425	0.410	0.535	0.507	0.492	0.617	0.589	0.197	0.224
10 x 32	0.190	0.331	0.299	0.285	0.426	0.394	0.380	0.521	0.489	0.475	0.616	0.584	0.570	0.711	0.679	0.227	0.256
1/4 x 28	0.250	0.411	0.375	0.375	0.536	0.500	0.500	0.661	0.625	0.625	0.786	0.750	0.750	0.911	0.875	0.292	0.326
5/16 x 24	0.312	0.500	0.458	0.469	0.656	0.615	0.625	0.812	0.771	0.781	0.969	0.927	0.937	1.125	1.083	0.361	0.400
3/8 x 24	0.375	0.562	0.521	0.562	0.750	0.708	0.750	0.937	0.896	0.937	1.125	1.083	1.125	1.312	1.271	0.424	0.468
7/16 x 20	0.437	0.662	0.612	0.656	0.881	0.831	0.875	1.100	1.050	1.094	1.319	1.269	1.312	1.537	1.488	0.496	0.549
1/2 x 20	0.500	0.725	0.675	0.750	0.975	0.925	1.000	1.225	1.175	1.250	1.475	1.425	1.500	1.725	1.675	0.559	0.617
9/16 x 18	0.562	0.812	0.757	0.844	1.094	1.038	1.125	1.375	1.319	1.406	1.656	1.601	1.687	1.937	1.882	0.628	0.691
5/8 x 18	0.625	0.875	0.819	0.937	1.187	1.132	1.250	1.500	1.444	1.562	1.812	1.757	1.875	2.125	2.069	0.690	0.758
3/4 x 16	0.750	1.031	0.969	1.125	1.406	1.344	1.500	1.781	1.719	1.875	2.156	2.094	2.250	2.531	2.469	0.823	0.901
7/8 x 14	0.875	1.196	1.125	1.312	1.634	1.562	1.750	2.071	2.000	2.187	2.509	2.437	2.625	2.946	2.875	0.958	1.051
1" x 12	1.000	1.375	1.292	1.500	1.875	1.792	2.000	2.375	2.292	2.500	2.875	2.792	3.000	3.375	3.292	1.097	1.199
1.1/8" x 12	1.125	1.500	1.417	1.687	2.062	1.979	2.250	2.625	2.542	2.812	3.187	3.104	3.375	3.750	3.667	1.222	1.334
1.1/4" x 12	1.250	1.625	1.542	1.875	2.250	2.167	2.500	2.875	2.792	3.125	3.500	3.417	3.750	4.125	4.042	1.347	1.469
1.3/8" x 12	1.375	1.750	1.667	2.062	2.437	2.354	2.750	3.125	3.042	3.437	3.812	3.729	4.125	4.500	4.417	1.472	1.610
1.1/2" x 12	1.500	1.875	1.792	2.250	2.625	2.542	3.000	3.375	3.292	3.750	4.125	4.042	4.500	4.875	4.792	1.598	1.745



Technical Data for BaerCoil® Wire Thread Inserts

BSW	1,0 D			1,5 D			2,0 D			2,5 D			3,0 D			F (inch)	
	T	D	B	T	D	B	T	D	B	T	D	B	T	D	B	min.	max.
1/8 x 40	0.125	0.237	0.212	0.187	0.299	0.274	0.250	0.362	0.337	0.312	0.425	0.400	0.375	0.487	0.462	0.155	0.173
3/16 x 24	0.187	0.375	0.332	0.281	0.468	0.426	0.375	0.562	0.520	0.468	0.656	0.612	0.562	0.750	0.708	0.237	0.256
1/4 x 20	0.125	0.475	0.425	0.375	0.600	0.550	0.500	0.725	0.675	0.625	0.850	0.800	0.750	0.975	0.925	0.309	0.331
5/16 x 18	0.312	0.562	0.507	0.469	0.719	0.663	0.625	0.875	0.819	0.781	1.031	0.976	0.937	1.187	1.132	0.378	0.401
3/8 x 16	0.375	0.656	0.594	0.562	0.844	0.781	0.750	1.031	0.969	0.937	1.219	1.156	1.125	1.406	1.344	0.449	0.472
7/16 x 14	0.437	0.759	0.687	0.656	0.978	0.906	0.875	1.196	1.125	1.093	1.415	1.343	1.312	1.634	1.562	0.522	0.551
1/2 x 12	0.500	0.875	0.792	0.750	1.125	1.042	1.050	1.375	1.292	1.250	1.625	1.542	1.500	1.875	1.792	0.598	0.630
9/16 x 12	0.562	0.937	0.854	0.844	1.219	1.135	1.125	1.500	1.417	1.406	1.781	1.698	1.687	2.062	1.979	0.661	0.694
5/8 x 11	0.625	1.034	0.943	0.937	1.347	1.256	1.250	1.659	1.568	1.562	1.972	1.881	1.875	2.234	2.193	0.732	0.767
11/16 x 11	0.687	1.097	1.006	1.031	1.441	1.350	1.375	1.696	1.694	1.718	2.128	2.037	2.062	2.472	2.381		
3/4 x 10	0.750	1.200	1.100	1.125	1.575	1.475	1.500	1.950	1.850	1.875	2.325	2.225	2.250	2.700	2.606	0.868	0.905
7/8 x 9	0.875	1.375	1.264	1.312	1.812	1.701	1.750	2.250	2.139	2.187	2.687	2.576	2.625	3.125	3.014	1.006	1.051
1" x 8	1.000	1.563	1.437	1.500	2.062	1.937	2.000	2.562	2.437	2.500	3.062	2.937	3.000	3.562	3.437	1.147	1.197
1.1/8" x 7	1.125	1.768	1.625	1.687	2.330	2.187	2.250	2.893	2.750	2.812	3.455	3.312	3.375	4.018	3.875	1.293	1.354
1.1/4" x 7	1.250	1.893	1.750	1.875	2.518	2.375	2.500	3.143	3.000	3.125	3.768	3.625	3.750	4.393	4.250	1.418	1.484
1.1/2" x 6	1.500	2.250	2.083	2.250	3.000	2.833	3.000	3.750	3.583	3.750	4.500	4.333	4.500	5.250	5.083	1.696	1.776

BSF	1,0 D			1,5 D			2,0 D			2,5 D			3,0 D			F (inch)	
	T	D	B	T	D	B	T	D	B	T	D	B	T	D	B	min.	max.
3/16 x 32	0.187	0.327	0.296	0.281	0.421	0.390	0.375	0.515	0.484	0.468	0.608	0.577	0.562	0.702	0.671	0.225	0.247
7/32 x 28	0.218	0.379	0.343	0.328	0.489	0.453	0.437	0.598	0.562	0.546	0.707	0.671	0.656	0.817	0.781		
1/4 x 26	0.250	0.423	0.385	0.375	0.548	0.510	0.500	0.673	0.635	0.625	0.798	0.760	0.750	0.923	0.885	0.296	0.331
9/32 x 26	0.281	0.454	0.416	0.421	0.594	0.566	0.562	0.735	0.697	0.703	0.876	0.838	0.843	1.016	0.978		
5/16 x 22	0.312	0.516	0.471	0.469	0.673	0.628	0.625	0.829	0.784	0.781	0.985	0.940	0.937	1.141	1.096	0.367	0.405
3/8 x 20	0.375	0.325	0.550	0.562	0.787	0.737	0.750	0.975	0.925	0.937	1.162	1.112	1.125	1.350	1.300	0.435	0.476
7/16 x 18	0.437	0.687	0.631	0.656	0.906	0.850	0.875	1.125	1.069	1.093	1.343	1.287	1.312	1.562	1.506	0.504	0.555
1/2 x 16	0.500	0.781	0.719	0.750	1.031	0.969	1.000	1.281	1.219	1.250	1.531	1.469	1.500	1.781	1.719	0.575	0.630
9/16 x 16	0.562	0.843	0.781	0.844	1.125	1.063	1.125	1.406	1.344	1.406	1.687	1.625	1.687	1.968	1.906	0.637	0.700
5/8 x 14	0.625	0.946	0.875	0.937	1.258	1.187	1.250	1.571	1.500	1.562	1.883	1.812	1.875	2.196	2.125	0.710	0.775
11/16 x 14	0.687	1.008	0.937	1.031	1.352	1.281	1.375	1.696	1.625	1.718	2.039	1.968	2.062	2.383	2.312		
3/4 x 12	0.750	1.125	1.042	1.125	1.500	1.417	1.500	1.875	1.792	1.875	2.250	2.167	2.250	2.625	2.542	0.849	0.925
13/16 x 12	0.812	1.187	1.104	1.218	1.593	1.510	1.625	2.000	1.917	2.031	2.406	2.323	2.437	2.812	2.729		
7/8 x 11	0.875	1.284	1.193	1.312	1.721	1.630	1.750	2.159	2.068	2.187	2.596	2.505	2.625	3.034	2.943	0.983	1.074
1" x 10	1.000	1.450	1.350	1.500	1.950	1.850	2.000	2.450	2.350	2.500	2.950	2.850	3.000	3.450	3.350	1.119	1.220
1.1/8" x 9	1.125	1.625	1.514	1.687	2.187	2.076	2.250	2.750	2.639	2.812	3.312	3.201	3.375	3.875	3.764	1.257	1.366
1.1/4" x 9	1.250	1.750	1.639	1.875	2.375	2.264	2.500	3.000	2.889	3.125	3.625	3.514	3.750	4.250	4.139	1.382	1.500
1.3/8" x 8	1.375	1.938	1.813	2.062	2.625	2.500	2.750	3.312	3.188	3.437	4.000	3.875	4.125	4.688	4.563	1.523	1.657
1.1/2" x 8	1.500	2.063	1.938	2.250	2.813	2.688	3.000	3.563	3.438	3.750	4.313	4.188	4.500	5.063	4.938	1.648	1.811

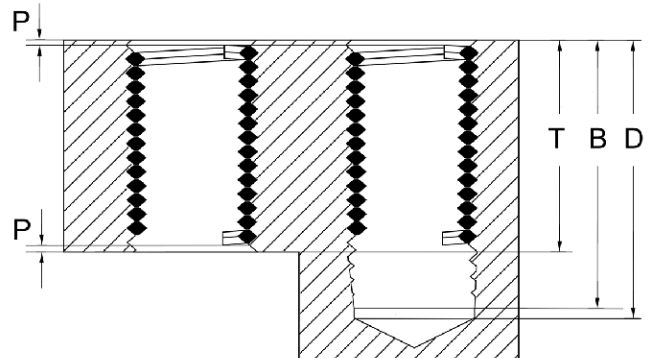

- P Installed insert 1/4 – 1/2 pitch below the surface
- T Length of Insert, when installed
- B Tap depth – including threads chamfer of plug tap
- D Drill depth (min.) - excluding point
- F Free coil diameter